

# Werkzeuge · Dies · Outils

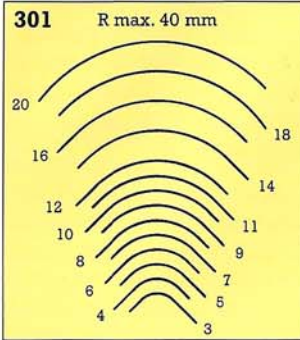

- Eckenrundung
- Round Corner
- Coin rond

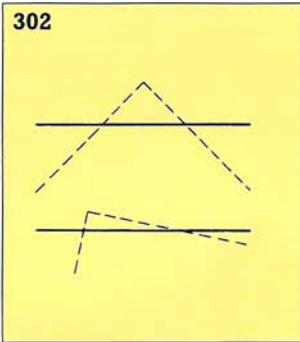

- Glatter Eckenabschnitt  
30 mm / 50 mm / 70 mm lang
- Straight Corner Cut  
30 mm / 50 mm / 70 mm long
- Pans coupés  
longueur 30 mm / 50 mm / 70 mm

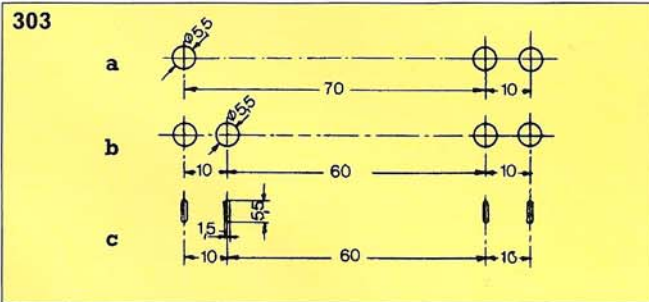

- Mehrfachlochung
- Multiple Hole Punches
- Perforations en ligne

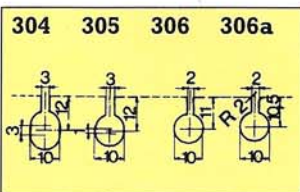

- Registerkartenschnitte
- Register Card Cuts
- Encoches pour classeurs

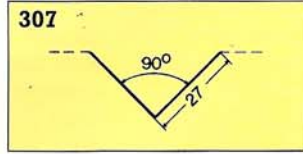

- Rechtwinkelschnitt
- Right Angle Cut
- Encoche triangulaire (angle droit)

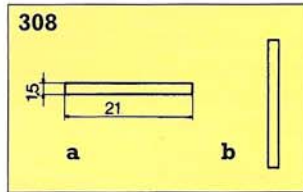

- Bandschlitz scharfkantig
- Slot Punch
- Fentes à bouts à angles vifs

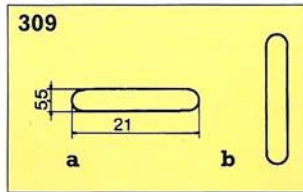

- Bandschlitz abgerundet
- Blind Thong
- Fentes à bouts arrondis

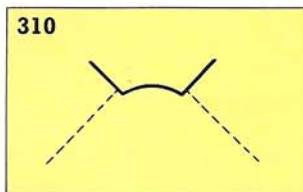
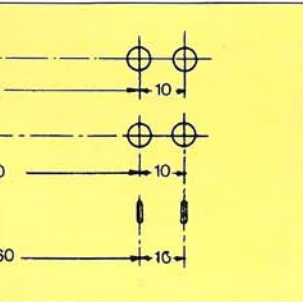

- Formecke
- Form Corner
- Coin à forme spéciale

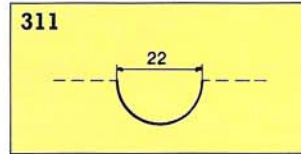

- Fingerhohlschnitt
- Thumb Cut
- Coup de pouce

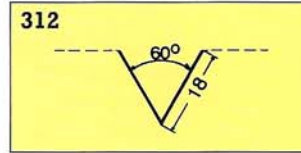

- Winkelschnitt
- Angle Cut
- Encoche triangulaire

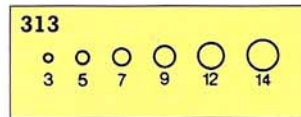

- Lochschnitte, Einzellochung
- Single Hole Punches
- Trou simple

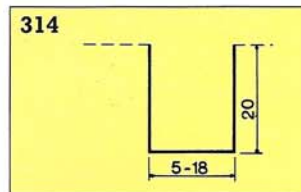

- Doppelwinkelschnitt
- Double Right Angle Cut
- Double découpe à angle droit

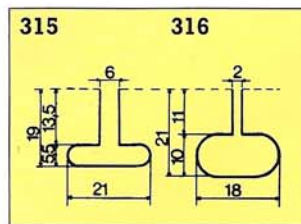

- Registerkartenschnitte
- Register Card Cuts
- Encoches pour classeurs

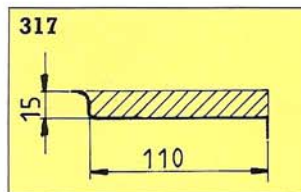

- Fahnschnitt
- Tab Cut
- Découpe classeur simple

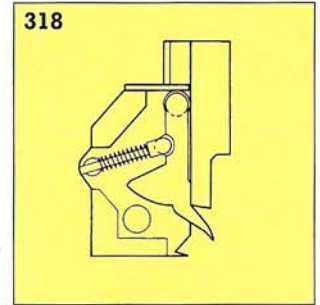

- Eckeneinziehwerkzeug mit Krallen, Radius nach Wahl
- Tool for Drawing-in Corners with claw, Radius at choice
- Outil de rembordage avec griffe, rayon au choix

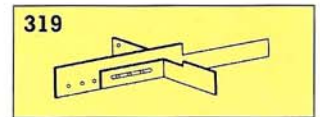

- Zweiteilige Winkelanlage
- Two Piece Angle Lay
- Equerre en deux parties

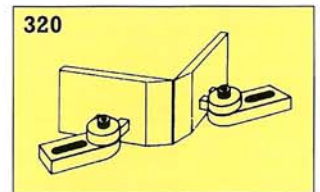

- Drehbare Winkelanlage
- Turning Angle Lay
- Equerre pivotante

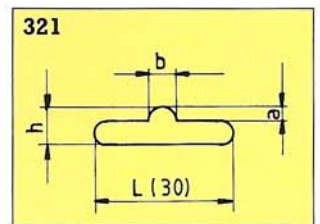

- Eurolochung
- Display Slot
- Encoche européenne